

# BPV



## Differential pressure relief valves

Proportional relief valve

# BPV

Used in heating and cooling systems, the BPV proportional relief valve works quietly to ensure a minimum flow level in the pump while maintaining the desired supply temperature when operating at low loads.

## Key features

- > **Adjustable set-point**  
For accurate differential pressure control.
- > **Shut-off function**  
For easy maintenance.
- > **AMETAL®**  
Dezincification resistant alloy that guarantees a longer valve lifetime, and lowers the risk of leakage.



## Technical description

### Applications:

Heating and cooling systems  
Tapwater systems

### Function:

Proportional relief  
Adjustable differential pressure ( $\Delta p$ )  
Shut-off

### Dimensions:

DN 15-32

### Pressure class:

PN 20

### Setting range:

10-60 kPa

### Temperature:

Max working temperature: 120°C  
Min working temperature: -20°C

### Materials:

Valve body: AMETAL®  
Bonnet: AMETAL®  
Cone: AMETAL®  
Stem: AMETAL®  
Union nuts: Brass  
Sleeve: Brass  
Cap: Brass  
Gaskets: Graphite  
Springs: Stainless steel  
O-rings: EPDM rubber  
Guide ring: PTFE

AMETAL® is the dezincification resistant alloy of IMI Hydronic Engineering.

### Marking:

Valve type, DN, inch size and flow direction arrow.

## Installation

### Application example

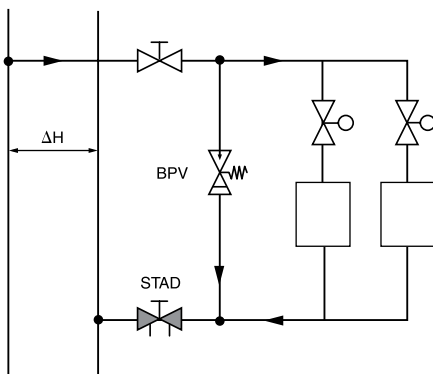

In installations with radiator valves, in which many of the radiator valves have closed, a big part of the pump head will affect the valves since the pressure drop in pipes and accessories has decreased. If the available differential pressure is higher than 30 kPa, noise may occur.

Install the BPV in the circuit after the balancing valve and between the supply and return pipe. The BPV is adjustable and opens at the preset differential pressure, making it possible to maintain desired pressure and flow in the distribution system. By that, the temperature in the pipes is also maintained and the pump is ensured a minimum flow.

## Setting

Use a 3 mm Allen key to adjust the BPV valve to operate at the required differential pressure.

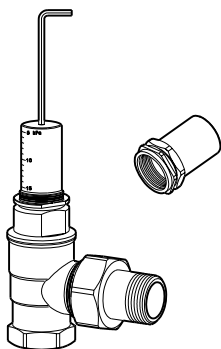

## Diagram

### Valve characteristics

Adjust the BPV valve to the required differential pressure (10-60 kPa). The valve characteristics will be as shown in the diagrams below.

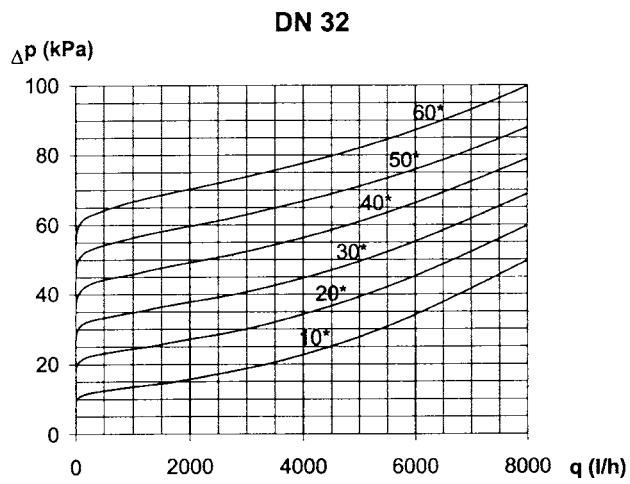
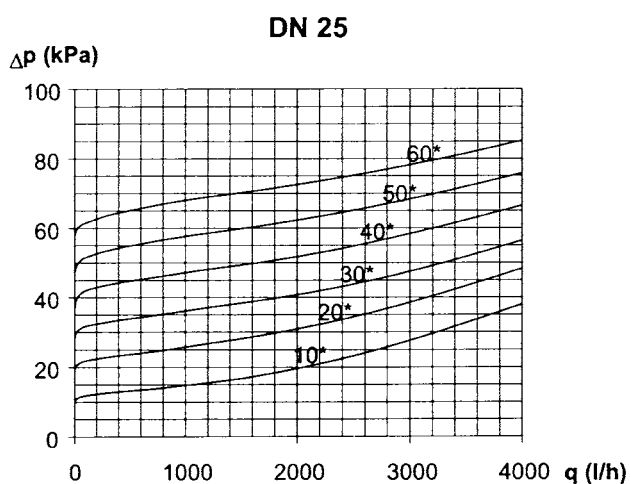
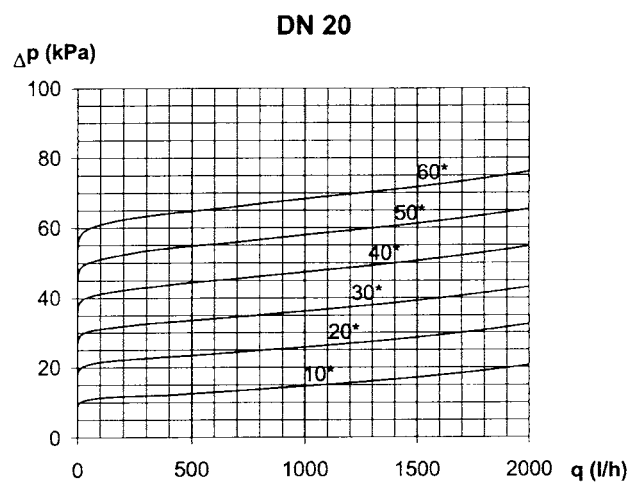
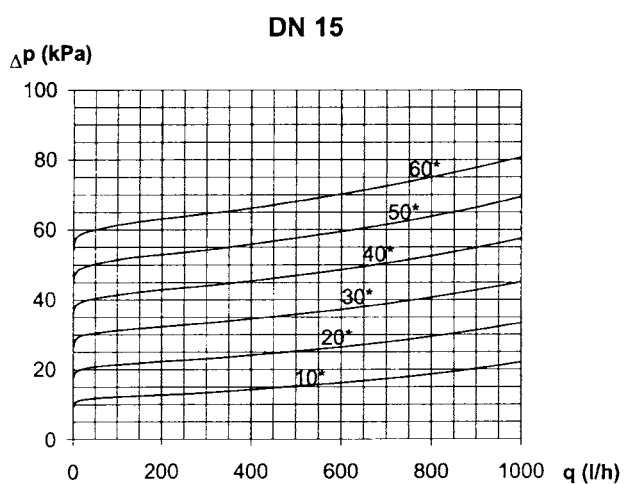

\*) Differential pressure setting.

## Articles

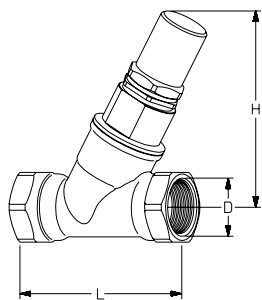
**Straight**

10-60 kPa

DN	D	L	H	EAN	Article No
15	G1/2	70	93	7318792851605	52 198-315
20	G3/4	85	93	7318792851704	52 198-320
25	G1	98	103	7318792851803	52 198-325
32	G1 1/4	112	105	7318792851902	52 198-332

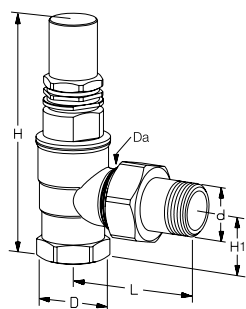
**Angle**

10-60 kPa

DN	d	D	Da	L	H	H1	EAN	Article No
20	R3/4	G3/4	M34x1,5	70	122	33	7318792851308	52 198-020
25	R1	G1	M40x2,0	83	138	41	7318792851407	52 198-025

**BPV DN 15 and DN 20 can be connected to smooth pipes with KOMBI compression couplings.** See catalogue leaflet KOMBI.