

FEBCO DCV 850 DATA

| DCV 850 | | | |
|---------|-----------|-----|-----|
| Code | Size (mm) | A | B |
| 850-15 | 15 | 445 | 160 |
| 850-20 | 20 | 430 | 160 |
| 850-25 | 25 | 510 | 190 |
| 850-32 | 32 | 640 | 260 |
| 850-40 | 40 | 700 | 260 |
| 850-50 | 50 | 770 | 260 |

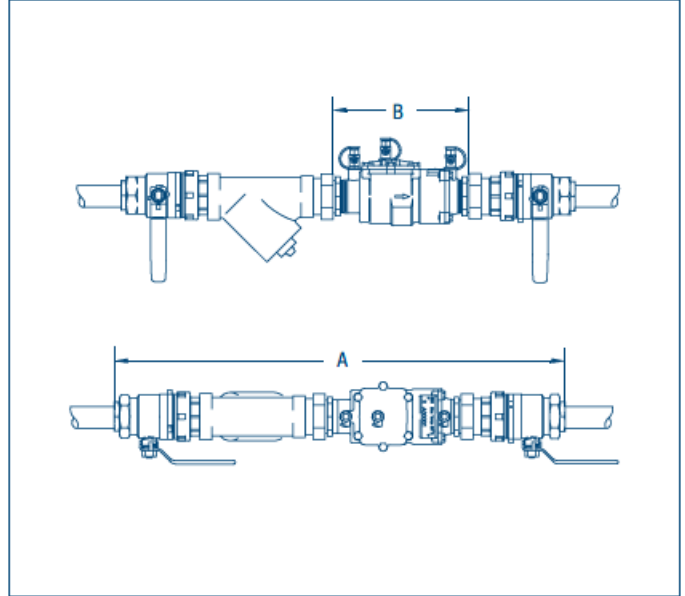

Double Check Assembly 15mm

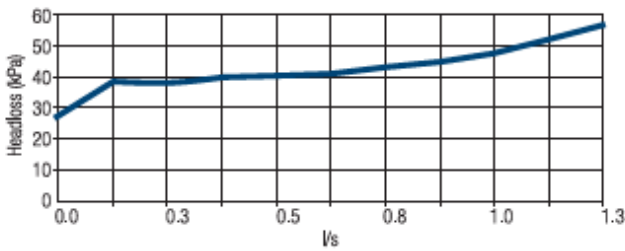

Double Check Assembly 32mm

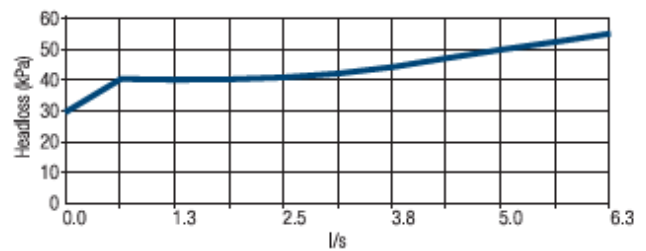

Double Check Assembly 20mm

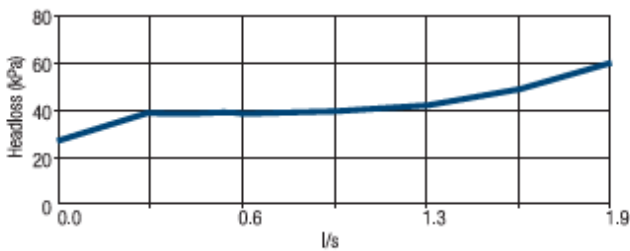

Double Check Assembly 40mm

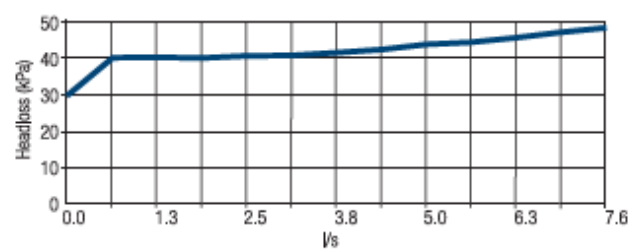

Double Check Assembly 25mm

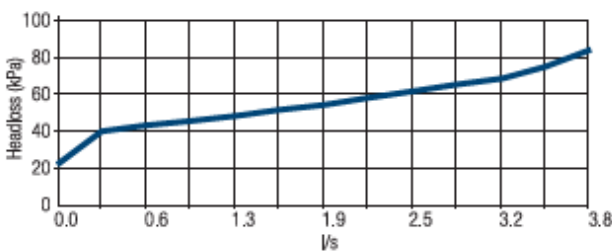

Double Check Assembly 50mm

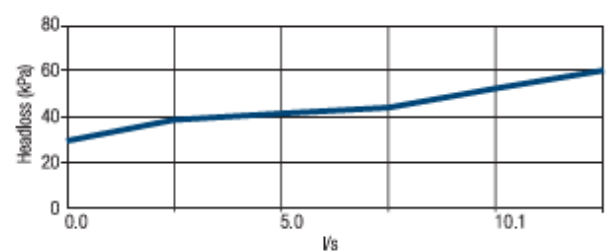

DCV 850

| Code | Size (mm) | A (RSGV) | B (BFV) | B | C (RSGV) | C (BFV) | D | E | G | H |
|---------|-----------|-------------|------------|--------|-------------|------------|--------|--------|--------|--------|
| 850-65 | 65 | 1300.70 | 1010.70 | 647.70 | 310.00 | 203.00 | 260.35 | 273.00 | 114.30 | 180.98 |
| 850-80 | 80 | 1351.90 | 1035.90 | 650.88 | 350.00 | 211.00 | 260.35 | 295.00 | 114.30 | 187.33 |
| 850-100 | 100 | 1521.20 | 1163.20 | 711.20 | 380.00 | 230.00 | 260.35 | 352.00 | 139.70 | 206.38 |
| 850-150 | 150 | 1886.65 | 1464.65 | 882.65 | 485.00 | 255.00 | 330.20 | 470.00 | 165.10 | 250.83 |

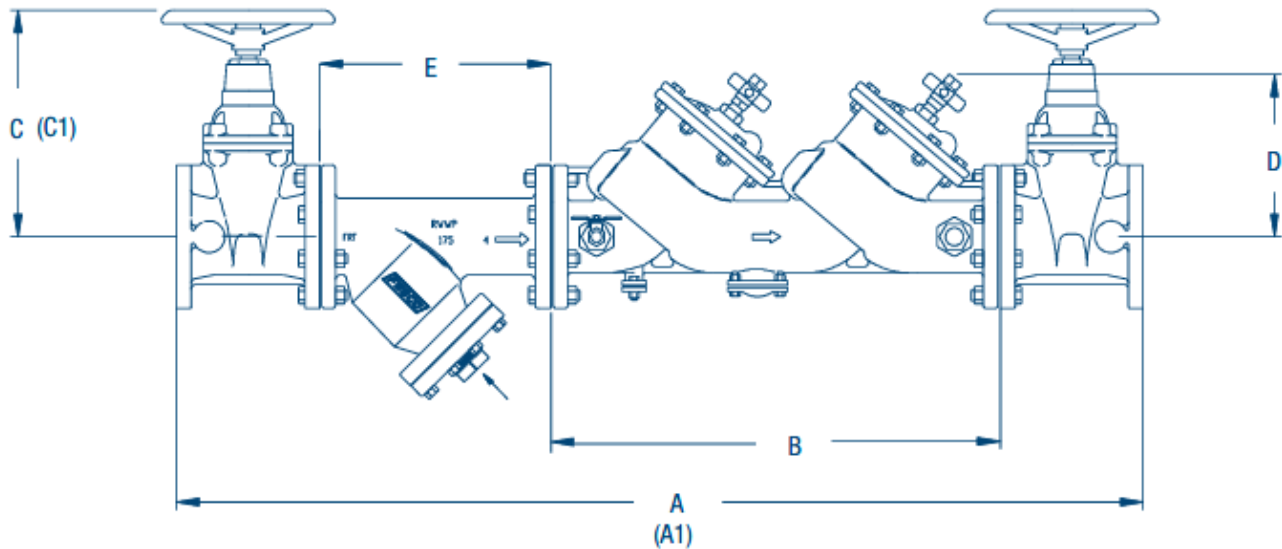
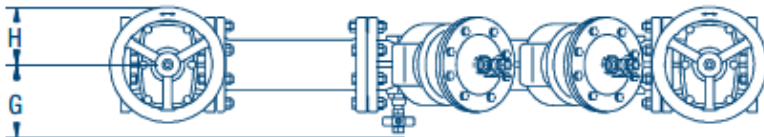

NB: (A1) & (C1) refer installation inc. BFV (not pictured)

*BFV = Butterfly Valves

RSGV = Resilient Seated Gate Valves (pictured)

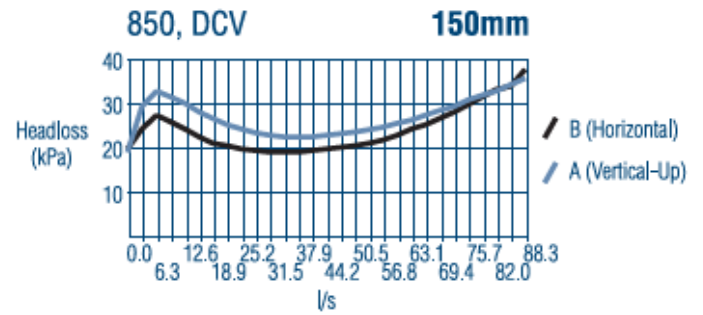
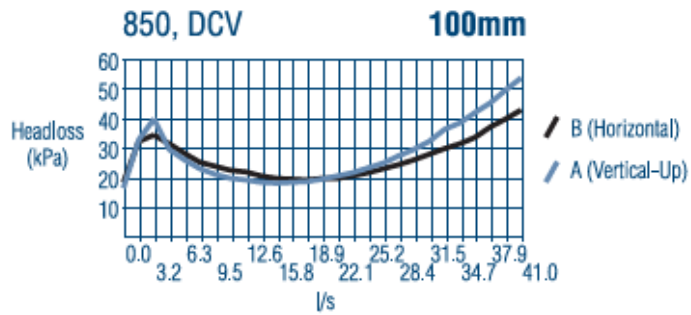
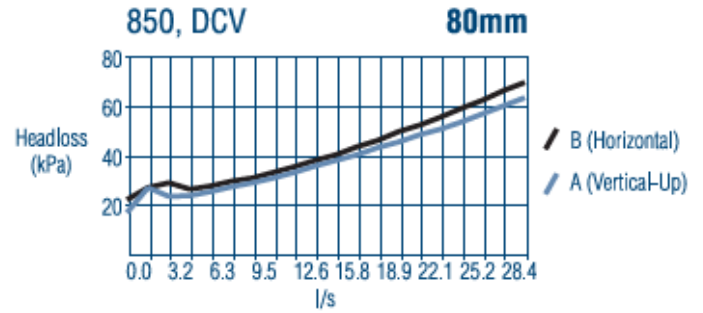
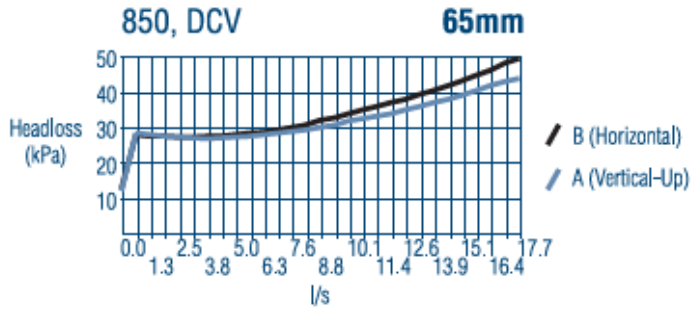

FEBCO RPZ 860 DATA

| RPZ 860 | | | |
|---------|-----------|-----|-----|
| Code | Size (mm) | A | B |
| 860-15 | 15 | 445 | 160 |
| 860-20 | 20 | 430 | 160 |
| 860-25 | 25 | 510 | 190 |
| 860-32 | 32 | 640 | 260 |
| 860-40 | 40 | 690 | 260 |
| 860-50 | 50 | 770 | 260 |

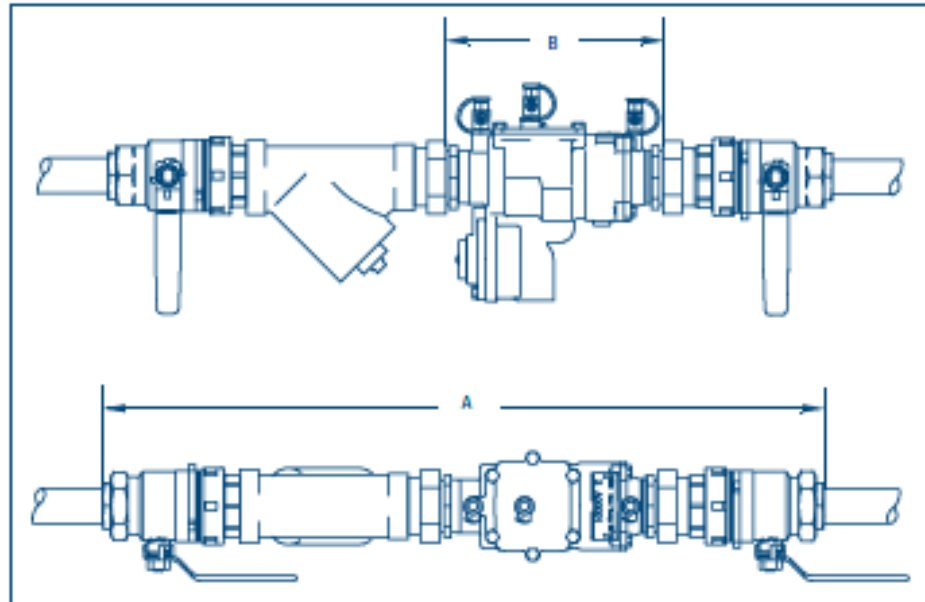

Reduced Pressure Assembly

15mm

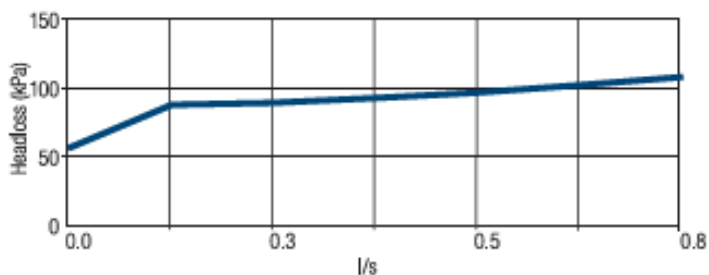

Reduced Pressure Assembly

32mm

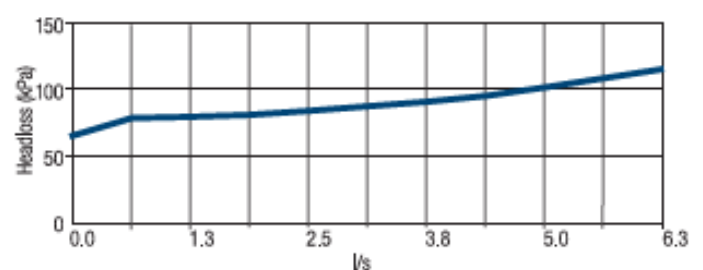

Reduced Pressure Assembly

20mm

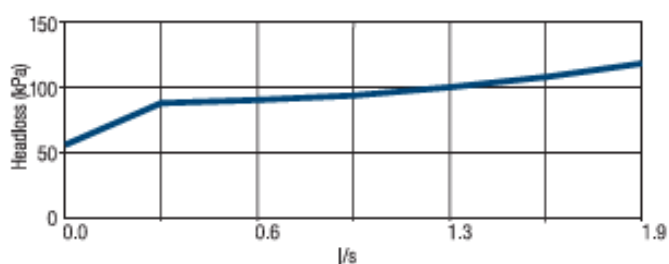

Reduced Pressure Assembly

40mm

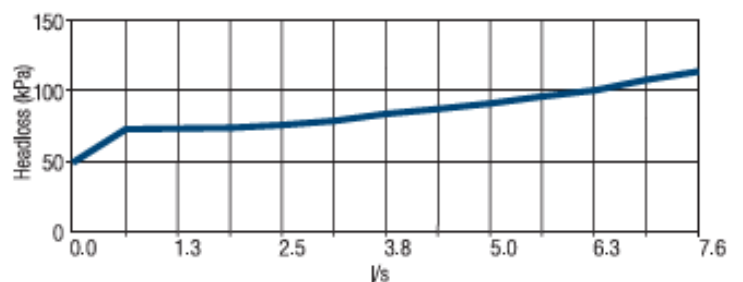

Reduced Pressure Assembly

25mm

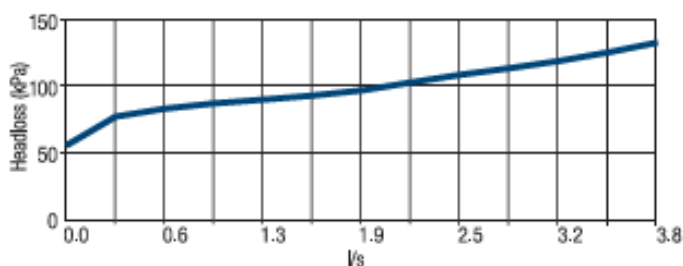

Reduced Pressure Assembly

50mm

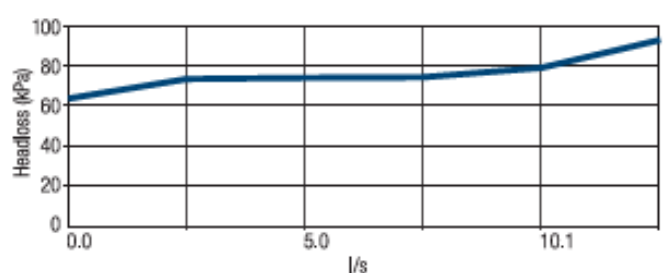

RPZ 860

| Code | Size (mm) | A (RSGV) | B (BFV) | B | C (RSGV) | C (BFV) | D | E | G | H |
|---------|-----------|-------------|------------|--------|-------------|------------|--------|--------|--------|--------|
| 860-65 | 65 | 1300.70 | 1010.70 | 647.70 | 310.00 | 203.00 | 254.00 | 273.00 | 114.30 | 181.10 |
| 860-80 | 80 | 1351.90 | 1035.90 | 650.88 | 350.00 | 211.00 | 254.00 | 295.00 | 114.30 | 187.45 |
| 860-100 | 100 | 1521.20 | 1163.20 | 711.20 | 380.00 | 230.00 | 257.30 | 352.00 | 139.70 | 206.50 |
| 860-150 | 150 | 1886.65 | 1464.65 | 882.65 | 485.00 | 255.00 | 323.85 | 470.00 | 165.10 | 250.95 |

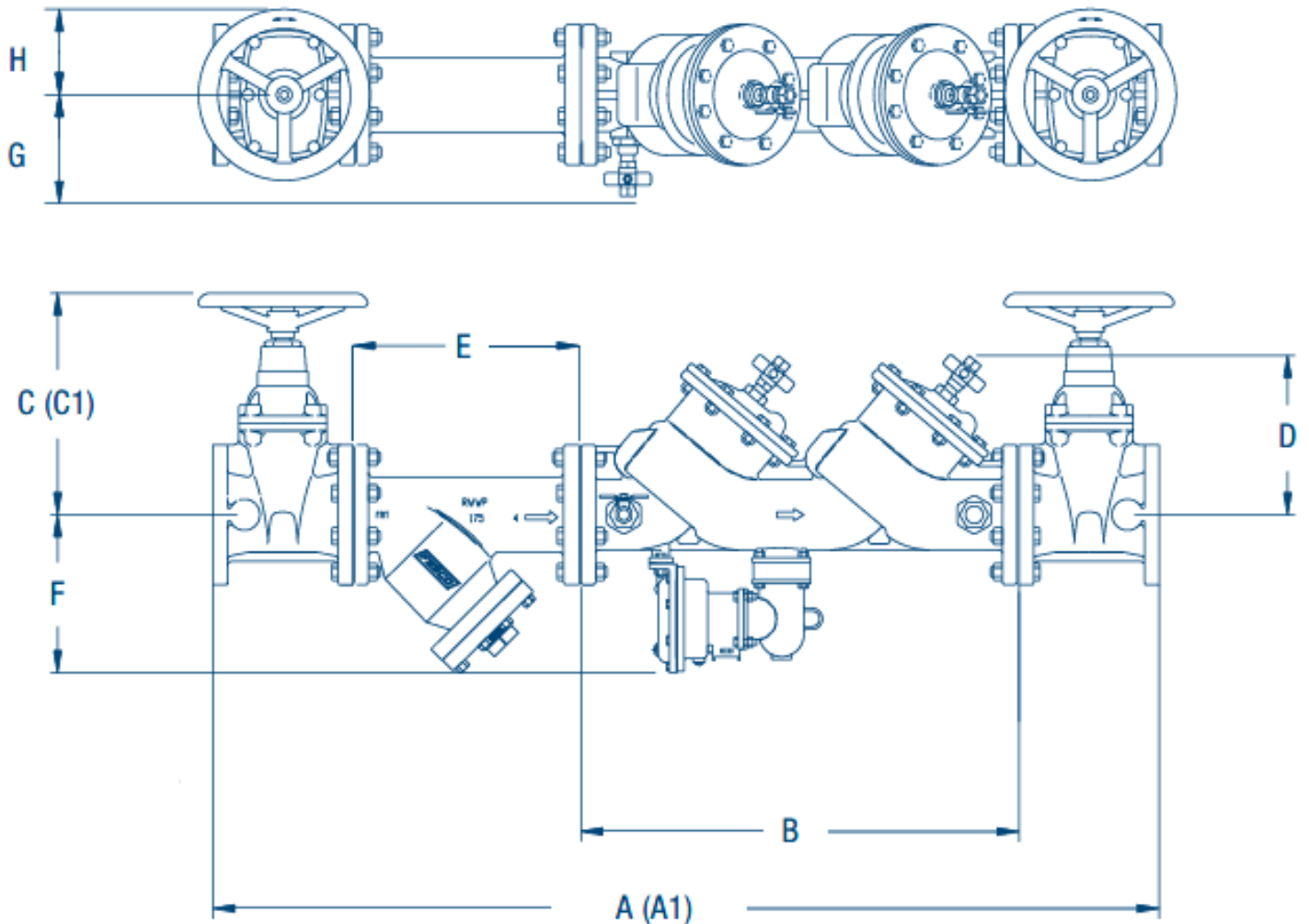

NB: (A1) & (C1) refer installation inc. BFV (not pictured) *BFV = Butterfly Valves RSGV = Resilient Seated Gate Valves (pictured)

